

Acoustic Plaster Ceilings

VoglToptec®



Attractive in Appearance,
Highly Active in Acoustics

The acoustic plaster system with
guaranteed results

Perfect acoustic plaster ceilings are a question of technique

Besides the acoustically highly effective perforated panels, acoustic plasters can also be used to significantly improve room acoustics through wall and ceiling surfaces. Each of these techniques can in itself offer a highly effective acoustic solution. Together they are an unbeatable team in terms of aesthetics and sound absorption. So far, however, working with conventional plaster base panels was more like using smooth gypsum plasterboards than a modern installation technique. VoglToptec® works quite differently and, above all, without requiring any filler.

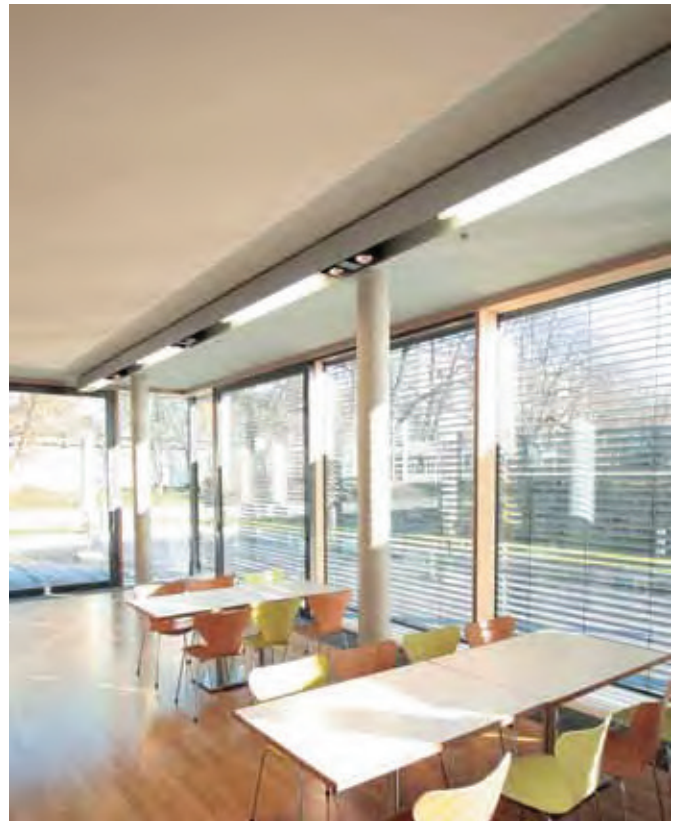

Economical and ultra-efficient:

A milestone in acoustic plaster ceilings:

- Elimination of board jointing results in considerable increase in perforated area, thus enhancing acoustic efficiency
- Quicker and more economical installation due to precise edge to edge mounting technique
- Sound absorption coefficient of up to $\alpha_w = 0.95$ (absorption class A)
- All from one source: the complete system, perfectly harmonised and tested
- Delivery includes Vogl screw kit



Layer build-up of the finishing coats

The acoustic plaster is machine-applied onto the plaster base fleece in three time-lagged operations until an open-pored plaster layer of approx. 3 mm thickness is achieved.



VoglToptec Akustik Nano SF

Machine-applied acoustic plaster with a very fine surface texture, grain size up to 0.5 mm.



VoglToptec Akustik Color

Coloured machine-applied acoustic plaster, pigmented throughout, according to RAL or other colour charts.



VoglToptec® acoustic plaster system panels are perforated ceiling panels with high acoustic performance (exception: type Reflexio which creates reflecting areas) for on-site lamination of the fleece plaster base (glass fibre fleece) and subsequent final coating with VoglToptec® acoustic plaster.

Acoustic fleece backing, all sides sharp-edged with undercut for installation using the quickest and most secure "edge to edge" laying principle.

Delivery including VoglToptec® screw kit (incl. perforated panel screws SN 3.5 x 30).

Standards: EN 14190 "Gypsum plasterboard products from reprocessing"
Material class: A2-s1, d0 or B1-s1, d0 (with foil) according to EN 13501
Long edge: SK (sharp-edged)
Short edge: SK (sharp-edged)



| Illustration | Item number | Description | Details | m ² /pallet Pcs./pallet |
|--------------|-------------|---|---|---------------------------------------|
| | 7221100010 | Acoustic plaster system panel Reflexio Acoustic fleece, black | 1206 x 2006 x 12.5 mm Perforated area: 0 % Mass: 10.0 kg/m ² | 60.5 m ² 25 pcs. |
| | 7221102110 | Acoustic plaster system panel 8/18R Acoustic fleece, black | 1194 x 2004 x 12.5 mm Perforated area: 15.4 % Mass: 8.5 kg/m ² | 59.8 m ² 25 pcs. |
| | 7221109110 | Acoustic plaster system panel 12/25Q Acoustic fleece, black | 1206 x 2006 x 12.5 mm Perforated area: 22.9 % Mass: 7.7 kg/m ² | 60.5 m ² 25 pcs. |
| | 7231113110 | Ultracoustic panel DLV 12/25R Acoustic fleece, black | 1232.5 x 1950 x 12.5 mm Perforated area: 33.9 % Mass: 6.5 kg/m ² | 60.0 m ² 25 pcs. |
| | 7221100080 | Acoustic plaster system panel 12/25Q Acoustic fleece, black and foil | 1206 x 2006 x 12.5 Perforated area: 22.9 % Mass: 7.7 kg/m ² | 60.5 m ² 25 pcs. |

VoglToptec® ultracoustic panel

The panel with integrated mounting instruction, thanks to surrounding and transverse screw-fixing and stop bars. Perfect evenness and enormous stability despite the very high degree of perforation of 33.9 %.

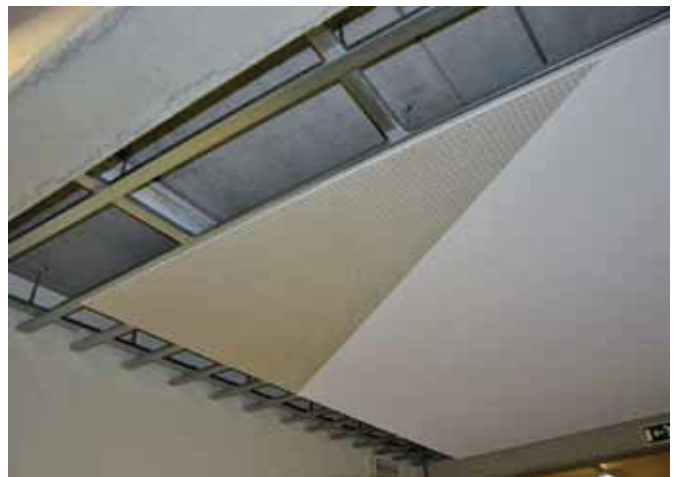

| Illustration | Item number | Description | Contents | PU PU/pallet |
|--------------|-------------|---|---|--|
| | 90501300 | Vogl Supergrund primer LF 20I Universal primer, absorbency regulating, free from solvents and softening agents, low-emission, free from active fogging substances. | 1 canister = 20 litres | 1 PU = 1 canister 24 canisters/pallet |
| | 90605000 | VoglToptec® plaster base fleece Special glass fibre fleece as plaster base for coating with acoustic plaster, not flammable, A2, crack-bridging properties, moisture-resistant, dimensionally stable, white colour. | Roll width 1145 mm Roll length 100 m | 1 PU = 1 roll 15 rolls/pallet |
| | 90608000 | VoglToptec® plaster base fleece, small Special glass fibre fleece as plaster base for coating with acoustic plaster, not combustible A2, crack-bridging, damp-proof, dimensionally stable, white colour. The handy-sized roll of plaster base fleece is especially suited for applying wallpaper in the perimeter/wall connection area as well as for custom solutions. | Roll width = 500 mm Roll length = 100 m | 1 PU = 1 roll |
| | 90604000 | VoglToptec® special adhesive Ready-to-use, dispersion adhesive, tested for harmful substances, for bonding the plaster base fleece to perforated ceiling panels, free from solvents and softening agents, low-emission, free from active fogging substances, ready-mixed product. | 1 bucket = 16 kg Consumption: approx. 0.3 kg/m ² | 1 PU = 1 bucket 24 buckets/pallet |
| | 90602000 | VoglToptec® Akustik Nano SF Decorative, open-pored, machine-applied acoustic plaster, very fine texture, grain size up to 0.5 mm, dull matt, high degree of whiteness, ready-mixed product. | 1 bucket = 18 kg Consumption: 2.7 - 3.0 kg/m ² | 1 PU = 1 bucket 24 buckets/pallet |
| | 90602100 | VoglToptec® Akustik Color Nano SF Decorative, open-pored machine-applied acoustic plaster, very fine texture, grain size up to 0.5 mm, ready-mixed product; please specify colour of choice (RAL etc.) when ordering. | 1 bucket = 18 kg Consumption: 3.0 - 3.5 kg/m ² * | 1 PU = 1 bucket 24 buckets/pallet |

*Note: Dark or special colour shades may lead to increased consumption. Actual quantities depend on the respective project.

System-inherent reliability!

The perfectly harmonised components are system tested and guarantee unparalleled reliability in terms of installation and performance of our acoustic plaster ceilings.

- 1 Acoustic fleece (and foil, if any) factory-supplied
- 2 VoglToptec® Acoustic plaster system panel
- 3 Plaster base fleece installed on-site
- 4 Acoustic plaster applied on-site

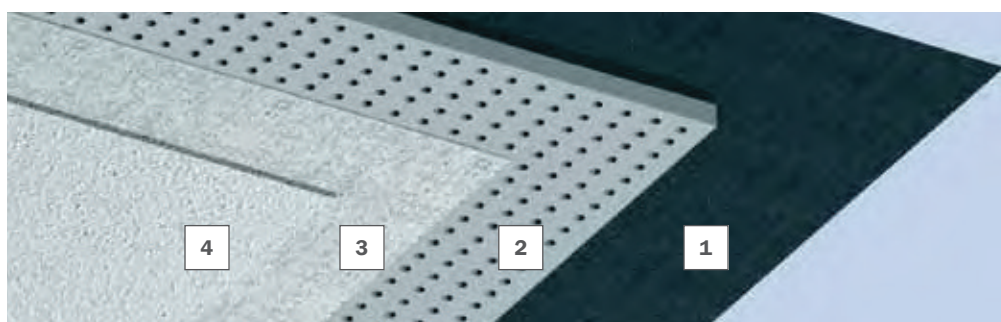

The primary profiles are rigidly hung from the structural soffit with suspended brackets using fixing materials approved by the relevant building authorities.

The centre distance and the number of suspended brackets as well as the fixing material are subject to site requirements and EN 13964/ DIN 18181. The CD 60/27 secondary profiles are attached to the CD 60/27 primary profiles using cross connectors.

CD 60/27 are extended using straight connectors. For primary grid profiles, always ensure that the joint is close to a suspended bracket

(max. 100 mm). Joints should generally be staggered.

The plasterboards should be installed in accordance with EN 13964/ DIN 18181 and the manufacturer's guidelines.

Additional items such as lighting, ventilation, sprinkler systems etc. must be individually suspended.

Any changes in the framework owing to integrated ceiling components must be considered.

| Framework, VoglToptec® | | | | | | | | |
|---|-------------------|--------------------------|------|------|------|------|--------|------|
| Technical data | Unit | Perforated panel ceiling | | | | | | |
| Panel thickness | mm | 12.5 | | | | | | |
| Distributed load | kN/m ² | ≤ 0.15 | | | | | ≤ 0.30 | |
| Centre distance of suspended bracket A | mm | 1150 | 1050 | 1000 | 950 | 900 | 900 | 750 |
| Centre distance of primary profiles X | mm | 600 | 800 | 900 | 1000 | 1100 | 600 | 1000 |
| Centre distance of secondary profiles Y | mm | see table below | | | | | | |

| Article | Unit | Centre distance of secondary profiles Y |
|---|------|---|
| VoglToptec® Acoustic plaster system panel 8/18R, 12/25Q, Reflexio (smooth) | mm | 334 |
| VoglToptec® Ultracoustic panel 12/25R DLV | mm | 325 |

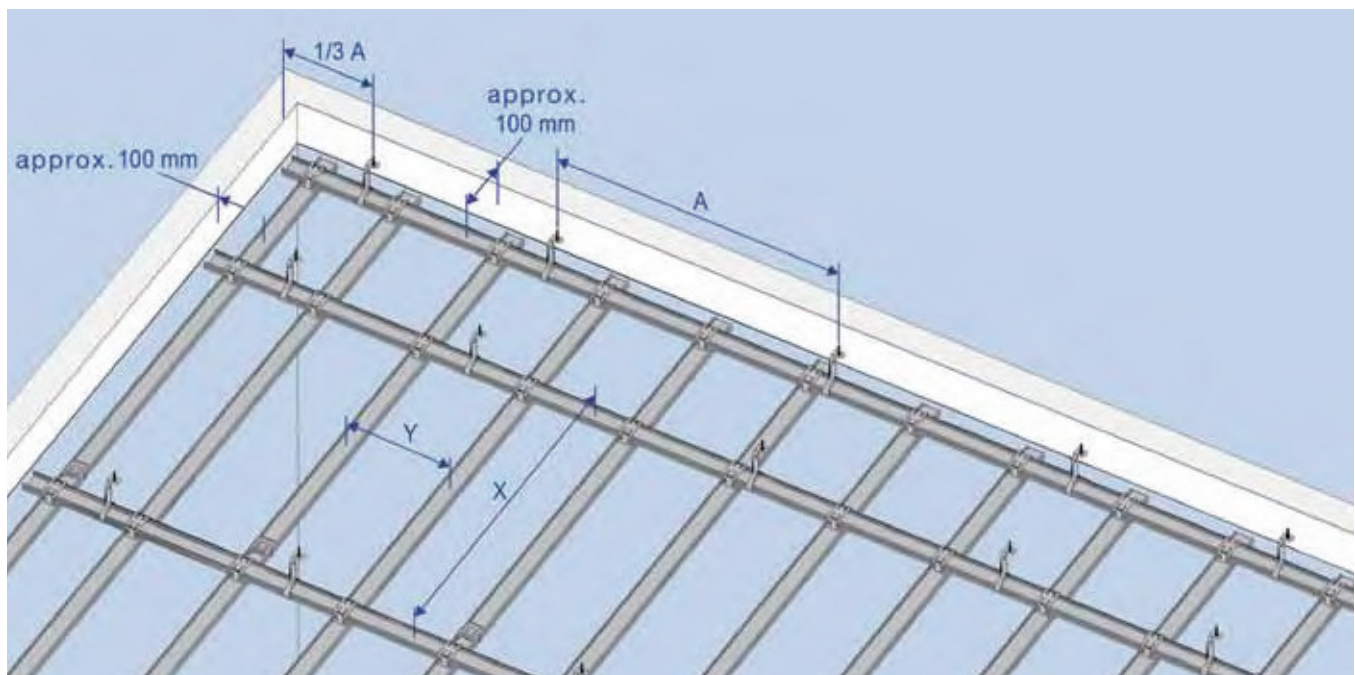

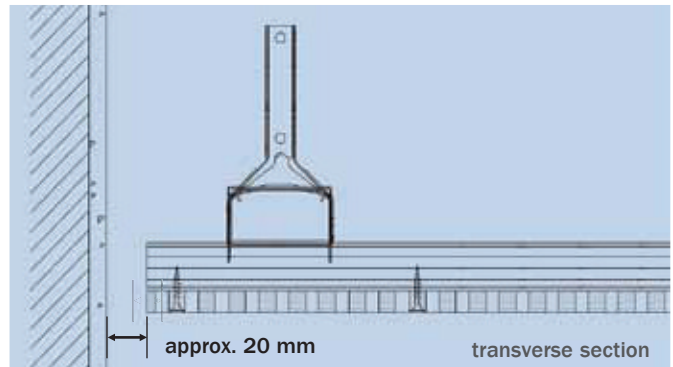
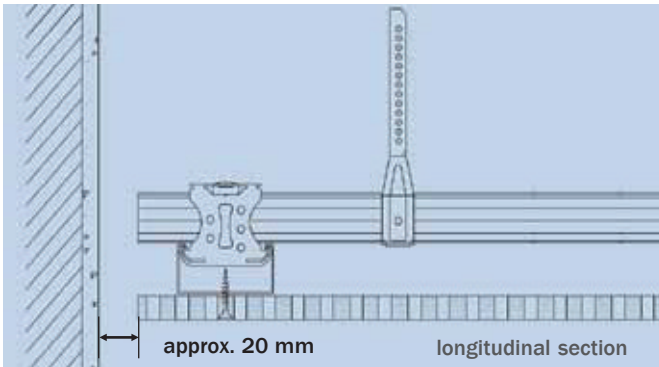

Wall connection:

To avoid different pressures/temperatures between the ceiling void and useable space, we recommend ventilating the ceiling. To do this, we advise you to fit the wall connection with an open shadow gap (approx. 20 mm) in the VoglToptec® system.

Please contact us if you require additional regulation details concerning the VoglToptec® system.

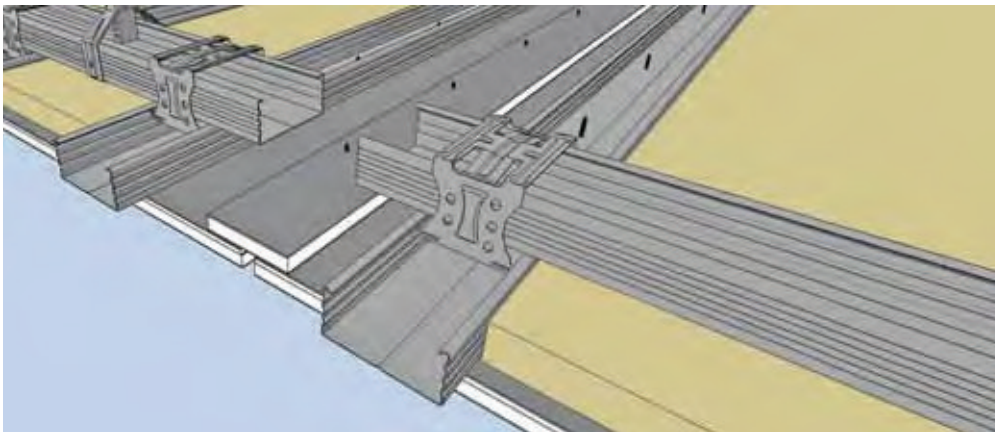

Expansion joints:

To prevent cracking in the ceiling surface, expansion joints have to be provided every 10 linear metres/100 m² of the ceiling area.

The framework must be completely severed (see illustration) and the panel strips above the joint must be screwed down on one side only.

Material required per m² based on a ceiling of 100 m² (10 m x 10 m, not considering loss or waste, approximate values):

Metal framework, suspended bracket centre distance 1000 mm, primary profile spacing 900 mm, secondary profile spacing 333 mm

| Item number | Article description | Unit | Quantity |
|--------------------------------|--|-------|----------|
| Fixation | | | |
| Standard | Safety nail, DN 6 x 35 | piece | 1.3 |
| Suspended brackets | | | |
| 2016X000 | Direct suspended bracket 50/120/200 and | piece | 1.3 |
| 50809000 | Tapping screw LN 3.5 x 9.5 | piece | 2.6 |
| or | | | |
| 20128/20151 | Vernier hanger/vernier bottom part and | piece | 1.3 |
| 25501000 | Vernier safety bolt and | piece | 1.3 |
| 25XXX000 | Vernier top part, 200 - 2000 mm, custom lengths on request | piece | 1.3 |
| Profiles and connectors | | | |
| 100XX000 | CD profile 60/27/0.6 rK, L=XXX mm | m | 4.1 |
| 20159000 | Connector, lengthwise, CD 60/27 | piece | 0.8 |
| 20135000 | Cross connector, CD 60/27 | piece | 3.3 |
| 52130000 | Perforated panel screw SN 3.5 x 30 | piece | 22 |

VoglToptec® Thermotec

The perfect solution for your acoustic plaster climate control ceiling

You want your acoustic plaster ceiling to be both visually attractive and provide efficient climate control performance? Then our VoglToptec® Thermotec system is just the right system for your project!

With the perfect combination of 10 mm VoglThermotec® panels and VoglToptec® acoustic plaster system, you will get optimum cooling capacity combined with sound absorption performance and an attractively finished surface. And of course, with our in-built reliable results – as all the system components come from the ceiling specialist Vogl Deckensysteme.

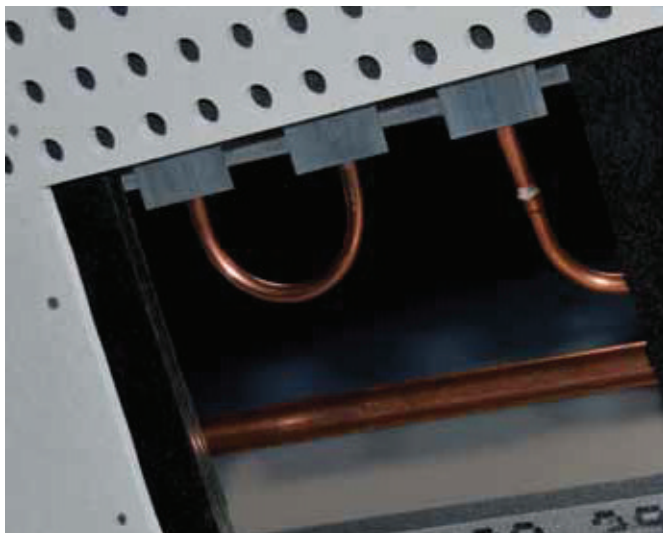

VoglToptec® backed with special foil

The right choice if you want your ceiling to be impermeable to airflow

As you might know, a ventilation system is often required to be installed within the ceiling void to meet air exchange requirements. In many cases, this ventilation is to take place only through the ceiling joints at the perimeters, and the rest of the ceiling surface must be airtight. Now there is a safe and easy-to-use solution for this application in the VoglToptec® system. With our special foil, laminated on the reverse of the boards, the acoustic plaster ceiling remains impermeable to airflow – but without compromising its acoustic performance. The ideal product if your finished ceiling ever comes “under pressure”.



Check ceiling framework for rigidity and evenness (using a straightedge).



Then check ceiling grid CD sections for centre distances and adjust, if necessary. Always mount straight connectors in a staggered manner (see figure). Measure centre distances accurately!

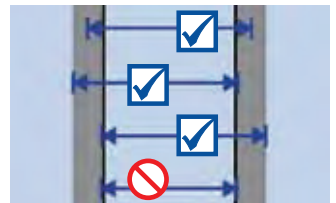
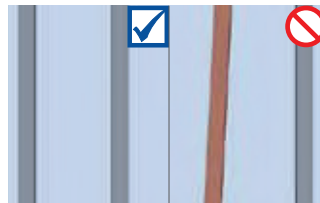

As viewed from entrance area, choose panel arrangement with short edges parallel to windows (main direction of light).



Exception: Ultracoustic panels with inherent screw bars.

Locate centre of room to position first ceiling panel, also taking into account resulting ceiling perimeter to wall connections.



We recommend the following assembly accessories:

Perforated panel screws, including screw bit

Correct handling of ceiling panels:

- Always take into account the load carrying capacity of the building when storing ceiling panels
- Do not store ceiling panels upright, but always flat on panel pallets
- Always carry ceiling panels with short edges upright
- Protect ceiling panels from moisture; relative humidity should be 40 - 80 %
- Avoid major temperature fluctuations
- Do not expose stored ceiling panels to direct sunlight

Get panel to correct position on framework using a panel lifter if working alone, or else another worker's help.



| Perforation pattern | Centre distance |
|--|-----------------|
| Acoustic plaster system panel 8/18R, 12/25Q, Reflexio | 334 mm |
| Ultracoustic panel 12/25R DLV | 325 mm |

Screws must be put into panel at right angles, and countersunk head screwed down to 0.5 mm below visible surface of ceiling panel.

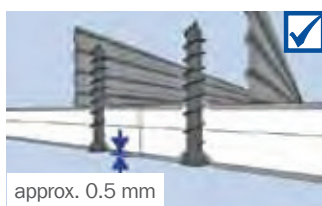

approx. 0.5 mm

Screws should be spaced maximum 170 mm from fixing point to fixing point. The distance between screw and panel edge shall not exceed 26 mm. Avoid damaging acoustic design panels by countersunk heads.

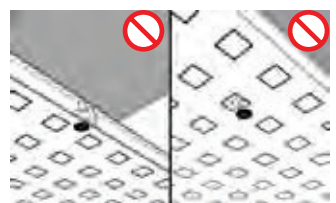

max. 170 mm

max. 26 mm

First, screw the ceiling panel to the framework in the centre of the panel, then lower the panel lifter and fix a screw in the centre of each short edge before finally screwing down long edges.

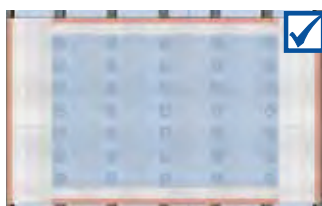

Take note of panel labelling (stamp) and mount in direction of reading (all stamps should point in same direction).



Use CD profile or straightedge as end stop. Position next panel by sliding it to first alongside CD profile/straightedge and fix in place.



General site conditions/Manufacturer's instructions:

- Take movement joints of building structure into account
- Plan to include expansion joints after approx. every 10 m or approx. 100 m²
- Cardboard layer must not be penetrated by screws, but merely displaced downwards
- Working temperature should be at least +10 °C and job site temperature not below +5 °C
- Installed ceiling surfaces must not be connected to perimeter walls
- Place any damping (mineral wool layer) directly onto the ceiling panels
- Carry out any additional work on ceiling (access openings, lighting recesses, etc.) immediately after installing ceiling panels

Fix screws in panel joint area using alternating pairs across panels ("zig-zag" principle), starting left or right next to screw which has already been fixed. This will create flush joint areas.

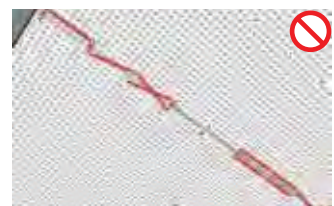
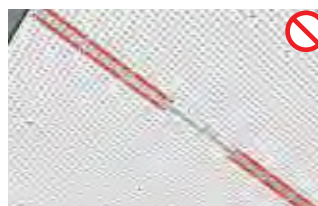

Install ceiling panels first lengthways, then crossways, resulting in cross arrangement on ceiling. Cover remaining areas in same manner, working from centre of room outwards.

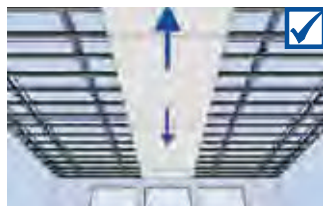

Lay remaining ceiling panels edge to edge, always checking that joints are level and using "cross joint" system only.

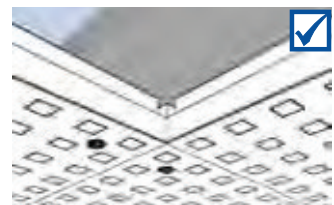

After all panels have been installed, recheck that all joints are level and adjust, if necessary, using a screwdriver. Then check with a straightedge.

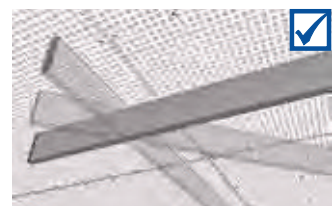
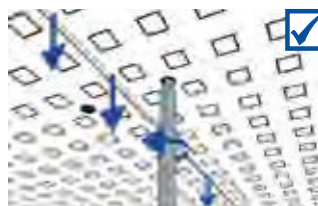

Place any damping layer directly onto back of ceiling panels. We recommend fitting an open shadow gap at the wall connection.

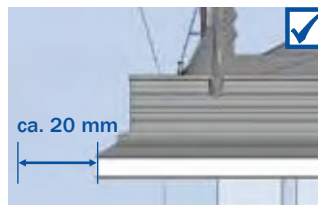

Provide for expansion joint of 5 to 10 mm every 10 linear metres/100 m².

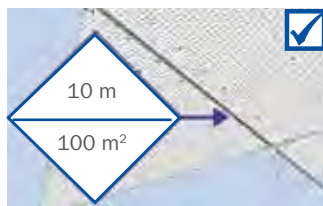

Additional board strip above joint must be screwed down on one side only.



Check panel joint areas and screw heads and adjust any height discrepancies using a screwdriver.



Prime ceiling surface with Vogl Supergrund LF. Subbase must be dry and free from dirt and separating substances. Apply primer in undiluted state using lambskin roller.



Drying time: 12 hrs



General site conditions/Manufacturer's instructions:

- Store primer, adhesive and acoustic plaster in ** frost-free environment **
- Reclose containers for extended work breaks
- Stir all materials well before use
- Working temperature should be at least +18 °C and job site temperature not below +10 °C
- Relative humidity: 40 - 80 %
- Self-levelling, cement or asphalt screeds must be fully dried – make sure there is no residual moisture
- Avoid shock heating or cooling of rooms during installation or drying times to prevent cracking
- Store away from sun and heat

Apply VoglToptec® Special Adhesive generously and evenly using lambskin roller and immediately install plaster base fleece into wet adhesive bed pushing it in with a wallpaper smoother. **Do not** spray-apply adhesive.



While applying fleece, make sure that special adhesive has not started to dry as this can cause bubbles. Place further lengths of plaster base fleece overlapping (5 - 10 cm) and separate using a double cut.



Check surface and joints. There must not be any adhesive on visible face of fleece (light marks).



Drying time: min. 12 hrs



Stir VoglToptec® Nano SF acoustic plaster slowly before use (2 - 3 minutes).



VoglToptec® Nano SF = ready-mix

Final coating of acoustic plaster - Manufacturer's instructions:

- Machine requirements: plaster spray system with worm conveyor (e.g. Strobot 204S) or delivery pump (e.g. InoBeam M8) and high-performance compressor (400 – 600 l/min)
- Spray distance (nozzle to ceiling) approx. 700 - 900 mm
- Air flow 1.5 - 2.0 bar
- Nozzle size 4 – 6 mm (depending on desired texture)
- Application quantities:
 1st coat approx. 700 g/m²
 2nd coat approx. 900 g/m²
 3rd coat approx. 1100 g/m²
 Total approx. 2700 g/m²

Optimum speckling pattern must be adjusted depending on job site.



(using brown cardboard, etc.)

Apply first layer by spraying-on acoustic plaster in circular motion.



Attention – avoid development of paint mist; holes must remain visible.



Drying time: 5 hrs

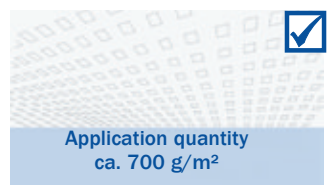
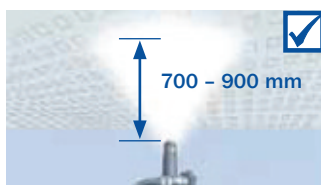

After drying period, apply 2nd coat to ceiling, also in circular motion; holes still slightly visible.



Drying time: 12 hrs

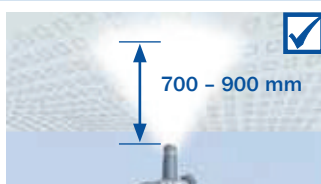

After drying period, apply 3rd coat to ceiling, also in circular motion; holes no longer visible.

Drying time: 12 hrs

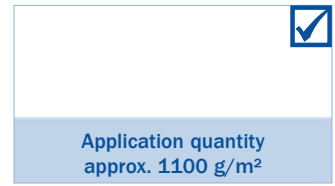
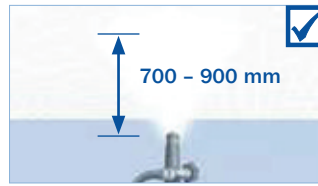

Renovation/ renewal of acoustic plaster coating

To remove any soiling, the ceiling can be given another machine-applied coating. Before application, sweep the ceiling with a fine hair broom.

Attention: Applying paint will affect the acoustic properties of the ceiling!



With circular motions, apply another coat to the ceiling surface. Depending on the degree of soiling, the application quantity of acoustic plaster can vary.

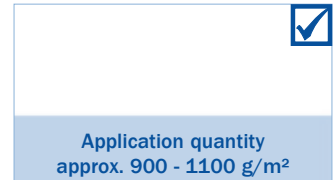
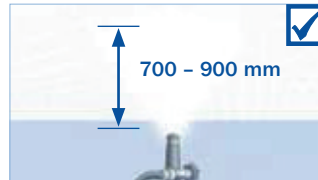

Quantities required for final coating per m² (not considering loss or waste)

| Item number | Article description | Unit | Quantity |
|-------------|-----------------------------------|----------------|---------------------|
| 90501300 | Vogl primer Supergrund LF | l | approx. 0.15 |
| 90604000 | VoglToptec® special adhesive | kg | approx. 0.30 |
| 90605000 | VoglToptec® plaster base fleece | m ² | approx. 1.00 |
| 90602000 | VoglToptec Akustik Nano SF | kg | approx. 2.70 - 3.00 |
| 90602100 | VoglToptec® Akustik Color Nano SF | kg | approx. 3.00 - 3.50 |

Acoustic plaster ceiling – VoglToptec® system

Acoustic plaster ceiling as suspended ceiling structure, one side clad with VoglToptec® acoustic plaster system panels, backed with acoustic fleece, mounted to a rigid ceiling framework of galvanised metal profiles, hung with flush and horizontally aligned suspended brackets and installed using fixing materials approved by the building authorities, with or without damping layer depending on building physics requirements. Installation in accordance with manufacturer's instructions, including all connection and jointing work as well as connection and fixing materials.

Ceiling system to accommodate an on-site application of machine-applied plaster consisting of VoglToptec® plaster base fleece and final coating using VoglToptec® acoustic plaster in accordance with manufacturer's instructions.

System structure

Framework in accordance with DIN 18181:2007-02

Profiles:

Pressure-resistant design made from galvanised sheet steel profiles CD 60/27 as primary and secondary profiles in accordance with EN 14195

Suspended brackets:

- Suspend with vernier systems (top part, vernier hanger),*
- Suspend with vernier systems (top/bottom part),*
- Suspend with direct suspended brackets, *
- Use fixing materials approved by the relevant building authorities.

Connection:

For primary-secondary profile connection with cross connectors, use suspended brackets and cross connectors in accordance with EN 13964,

suspended bracket centre distance: max. 900 mm,
 primary profile centre distance: max. 1.100 mm,
 secondary profile centre distance: 325/334 mm.*

Covering:

Acoustic plaster system panels are perforated ceiling panels in accordance with EN 14190, backed with acoustic fleece, one layer 12.5 mm, laid edge to edge and fixed to the framework using perforated panel screws SN 30, with screw spacing max. 170 mm. Observe manufacturer's installation guidelines.

Perforation pattern/perforated area/mass per unit area:

- Reflexio/0.0 %/10.0 kg/m² *
- 8/18 round/15.4 %/8.5 kg/m² *
- 12/25 round/22.9 %/7.7 kg/m² *
- Ultracoustic 12/25R DLV/35.3 %/6.5 kg/m² *

Distributed load:

- Less than or equal to 0.15 kN/m² *
- Less than or equal to 0.30 kN/m² *

Joint finishing:

VoglToptec system in accordance with manufacturer's instructions, edge to edge installation principle, filler-free. Sand down area of screw heads and panel joints level, paying attention to leave the screw heads unsanded. No filling required. Observe manufacturer's installation guidelines.

Subbase:

Suspension height: h = mm
 Installation height: h = mm
 Room height: h = mm
 Insulation thickness: th = mm

Subsequent application: final coating in VoglToptec® System

Complete system: Vogl Deckensysteme, or equivalent

* Delete as applicable

